

■ PT - peristaltic pumps

brochure 2012 rev 1

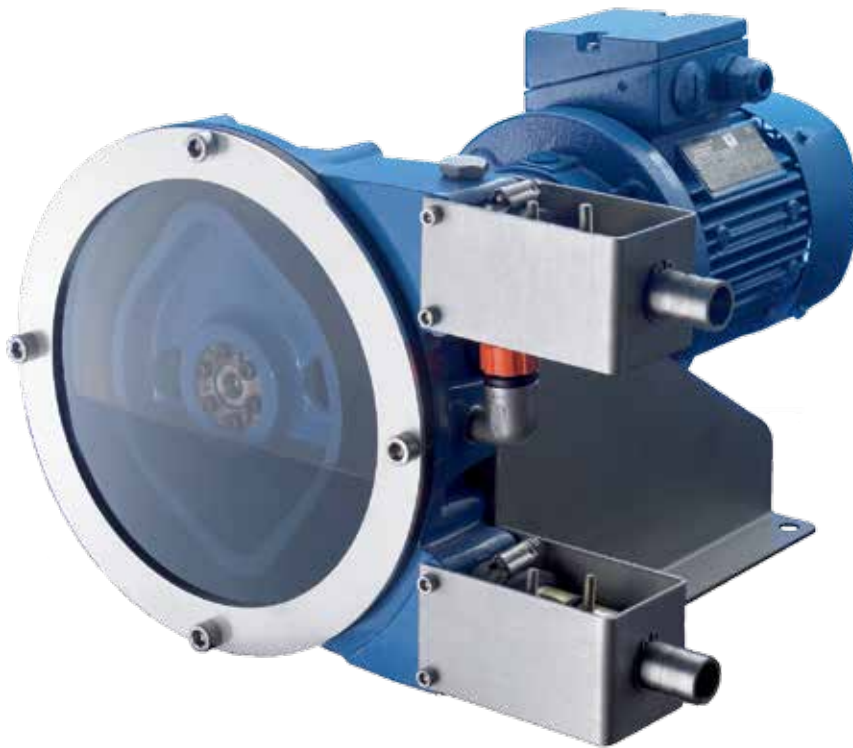

topflo®

PT peristaltic pumps - hose pump

The Tapflo PT pump combine the best available materials with smart design solutions in order to maximise running time and minimise maintenance.

Our design enhances the pump's simplicity and robust principle. PT summarizes what we at Tapflo want to achieve: better pump solutions for our customers.

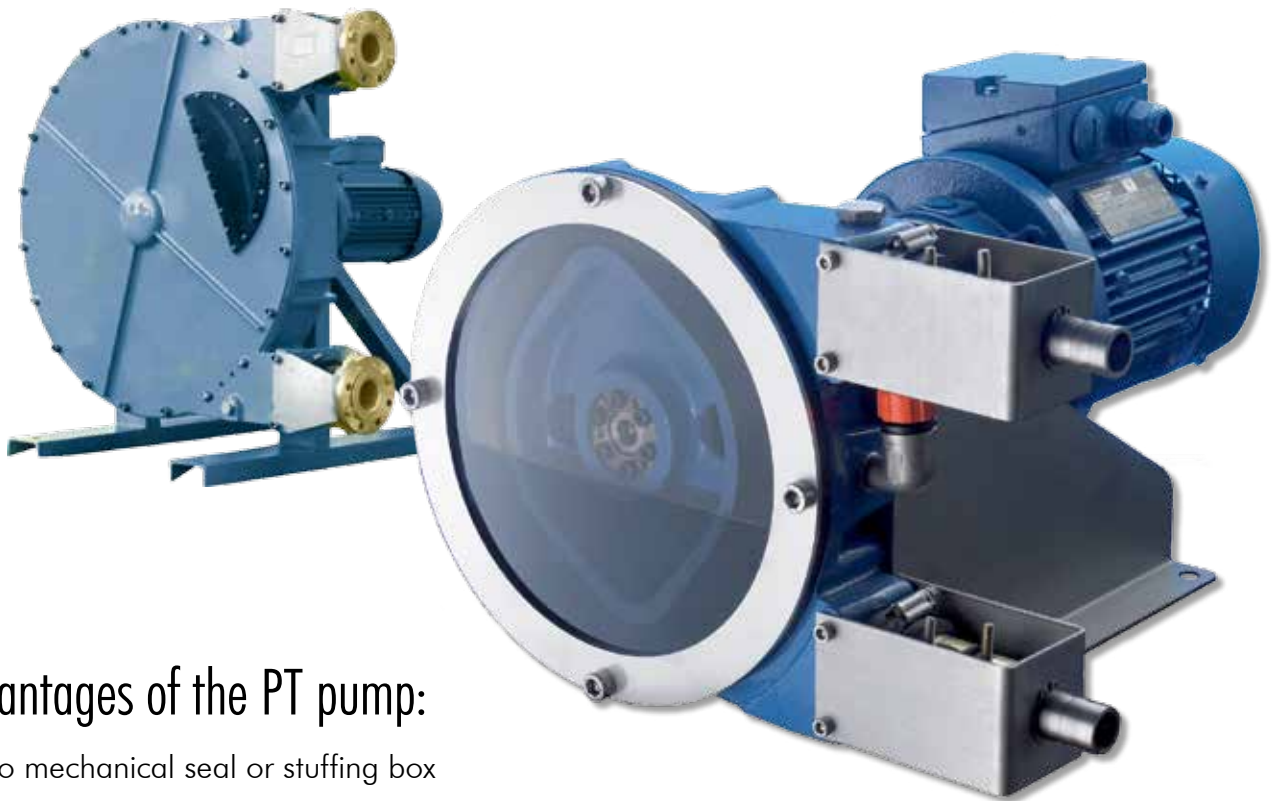

Advantages of the PT pump:

- No mechanical seal or stuffing box
- Robust, entirely of ductile iron
- Suitable for aggressive or viscous fluids
- Dosing of very corrosive chemicals
- Fully self-priming up to 9,8 m
- Damage-free continuous dry running
- Outlet pressures up to 15 bar
- Very easy maintenance
- Heavy-duty bearings, greased for life
- Two-year warranty
- Plug and Play
- Reversible flow
- Close coupled with gearbox protection
- Low sound level : < 70 dB at 1meter

The PT hose pump is in many ways the future of pumping – a reliable pump with a wide performance range, up to 150 m³/h and 15 bars, that can handle most fluids in most applications.

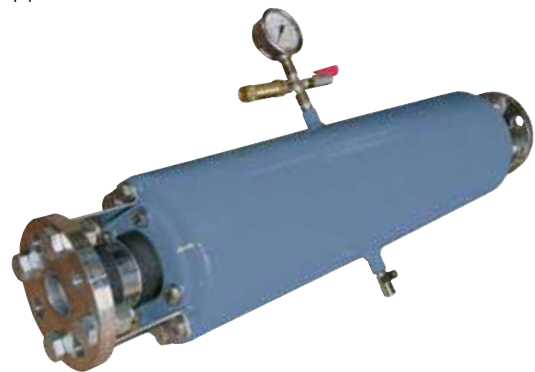

The Tapflo PT pump in-line pulsation dampener will reduce vibration and water hammers in your piping therefore increasing the hose life.

Easy to use and maintain – two key issues that will

lower costs & reduce downtime

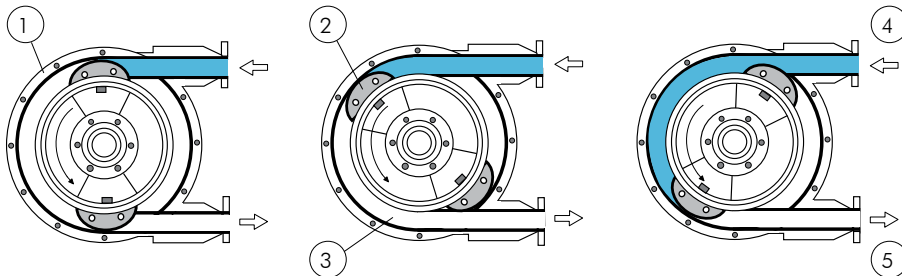

1. Pump casing
2. Shoe
3. Hose
4. Suction side (inlet)
5. Discharge side (outlet)

How it works

Two shoes mounted at 180° on a rotating wheel compress successively a reinforced rubber hose that contains a fluid to be pumped. The compression of the hose by the rotating shoes creates continuous suction at the inlet of the pump and pushes the fluid to the outlet of the pump.

The pump casing contains a lubricant that reduces friction and insures the best pump performance with a minimum of maintenance. The pumped fluid is in contact only with the interior of the rubber hose, thus permitting the pumping of a wide variety of reactive fluids.

Easy to use

The PT pump is very easy to use and maintain and therefore addresses what we at Tapflo see as two of the key customer issues : the need to lower costs and to reduce downtime. This is done by using a pump without valves, pistons, stators or rotating elements in the fluid. The PT series is designed to make hose changes quick and easy with no technical knowledge required.

Tapflo PT hose construction

We only work with high quality compounded rubbers, reinforced with 2 to 6 individual layers of braided polyamide and with an outer layer made to strict tolerances to ensure perfect compression. The characteristics of Tapflo hoses enable them to last approximately 30 % longer than other hoses on the market. They also fit the majority of other hose pumps.

Options

- Twinhead pump, several pump bodies inline driven by the same gear motor
- Special executions and different connections such as SMS, Clamp, DIN, ANSI, coupling and cover...etc
- Pump rollers for pump without lubricant
- Hose rupture detector and revolution counter
- ATEX II & I certification

Typical Applications

Water treatment lime cream, ferrous chloride, activated carbon, reagent feed, coagulant, flocculate dispersion, alum, sludge and foams.

Mineral processing sludge with viscosity up to 60 000 cps, clay up to 800g/l, particle size: 30 mm, lead sulfate, pyrite, sabx, cyanide, various acids.

Ceramic barbotine, mould filling, filter press feeding. Building fibrous mortar, plaster, light concrete, cement flooring.

Chemical industry various acids, pvdf latex, alcohol, soap, non aromatic solvents.

Food industry tomato sauce, mash potatoes, gelatin, beer yeast, fish paste, olive oil, wine. Paint, water based paint, acrylics, pigments, ink, wall coating.

Paper mills latex, kaolin, paper waste sludge, various chemical dosing.

Agriculture manure, fertilizer sugar mills, molasse, liquid sugar and various chemicals.



Tapflo pump hose For the hose inner layers, 6 materials are available to suit the diversity of the pumped fluids:

- NR: Natural rubber (white marking) (white & yellow marking)
- EPDM (red marking)
- NBR: Buna (yellow marking)
- HYPALON* (blue marking)
- NBR Food* approved FDA: Buna (white & yellow marking)
- VITON/FKM* (purple marking)

*Any other hose material requirements available on request

PT peristaltic pumps - technical characteristics

Construction

PT 05 - 20

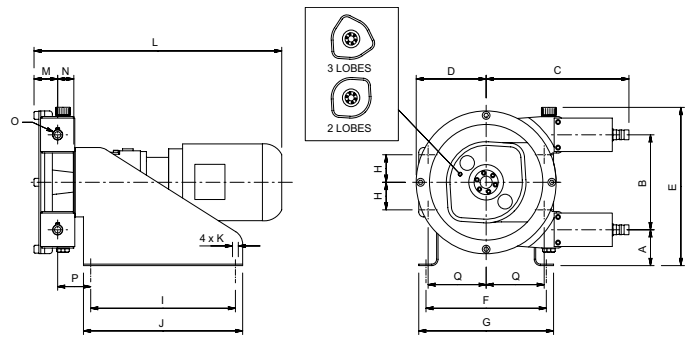

PT 25 - 40

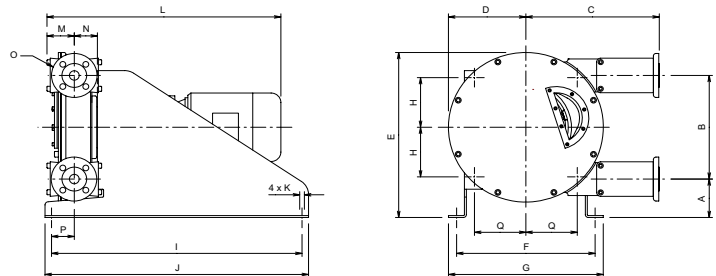

PT 40 - 125

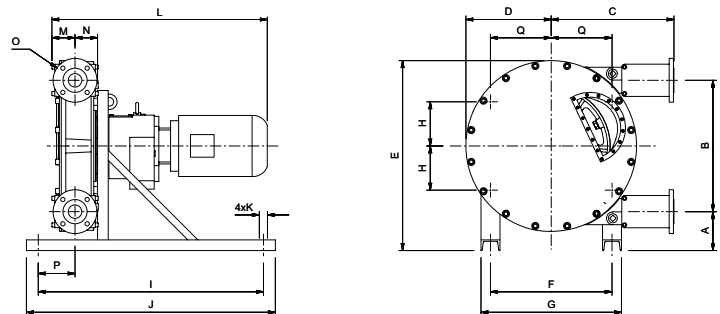

Dimensions

All dimensions and technical data is subject to change without notice

TYPE	A	B	C	D	E	F	G	H	I	J	K	L	M	N	O (Brides ISO)	P	Q
PT 05	103,5	115	226	95	256	220	240	33,5	260	280	4xø9	-	46,5	34,5	ø16 *	56	81,25
PT 10	103,5	115	226	95	256	220	240	33,5	260	280	4xø9	-	46,5	34,5	ø16 *	56	81,25
PT 15	73	193	296	145	322	250	280	51,75	300	330	4xø13	-	49	35,5	ø20 *	68,8	124,75
PT 20	73	193	296	145	322	250	280	51,75	300	330	4xø13	-	49	35,5	ø25 *	68,8	124,75
PT 25	95	262	355,5	190	416	311	351	110	560	600	4xø13	-	65	69	DN25 PN16	61	110
PT 32	122,5	330	435,5	238	525,5	426	476	157,75	770	810	4xø13	-	83	89	DN32 PN16	109	157,75
PT 40	122,5	330	435,5	238	525,5	426	476	157,75	770	810	4xø13	-	83	89	DN40 PN16	109	157,75
PTX 40	110	430	400	291	616	340	420	170	850	950	4xø19	-	75	86	DN40 PN16	87	170
PT 50	164,5	554	517,5	360	801,5	513	593	186,5	950	1050	4xø19	-	94,5	102	DN50 PN16	152	256,5
PT 65	164,5	554	517,5	360	801,5	513	593	186,5	950	1050	4xø19	-	94,5	102	DN65 PN16	152	256,5
PTX 80	154	746	604	473	1004	580	680	290	1150	1250	4xø19	-	129	123	DN80 PN16	117	290
PT 80	262	876	803	555	1320	690	830	345	1300	1400	4xø27	-	140,5	142	DN80 PN16	210	345
PT 100	300	1040	887	685	1680	820	960	410	1900	2000	4xø27	-	149	174	DN100 PN16	295	410
PT 125	263,5	1273	1038	785	1750	1000	1140	500	1900	2000	4xø27	-	300	232	DN125 PN16	660	500

Flow table (l/h)

TYPE	10 rpm	20 rpm	40 rpm	60 rpm	80 rpm	100 rpm	120 rpm	140 rpm
PT 05 (3 lobes)	3.4	6.8	13.6	20.4				
PT10 (3 lobes)	10	20	40	60				
PT 10	15	30	60	90	120	150	180	
PT 15	50	100	200	300	400	500	600	
PT 20	65	170	340	500	670	850	970	
PT 25	200	400	800	1 200	1 600	2 000	2 400	2 800
PT 32	375	750	1 500	2 250	3 000	3 750	4 500	5 250
PT 40	565	1 170	2 340	3 510	4 680	6 850	7 020	8 190
PTX 40	800	1 600	3 200	4 800	6 400	8 000		
PT 50	1750	3 500	7 000	10 500	14 000	17 500		
PT 65	2300	4 600	9 200	13 800	18 400	23 000		

Continuous use (l/h)

Intermittent use (l/h)

Occasional use (l/h)
< 1 hour/day

TYPE	10 rpm	20 Rpm	30 Rpm	35 Rpm	40 Rpm	45 Rpm	50 Rpm
PTX 80	5 500	11 000	16 500	19 250	22 000	24 750	27 500
PT 80	7 000	14 000	21 000	24 500	28 000	31 500	35 000
PT 100	12 000	24 000	36 000	42 000	48 000	54 000	
PT 125	22 000	44 000	66 000	77 000	88 000		

Tapflo PTS serie

for customers who require a long shaft technology, Tapflo has also developed the PTS series. These pumps are equipped with a removable bearing case for easy

bearing maintenance and can be converted into a close coupling PT type pump at any time.



Flow curves PT pump

How to use the pump curves

1. Select the required flow. This gives you the required pumpspeed.
2. Move upwards to the calculated discharge pressure.
3. Move to the left for the installed motor power.
4. Determine the fluid's max. temperature.
5. Move to the left to the calculated discharge pressure.
6. Move downwards to determine your maximum allowed pump speed for the fluids temperature.

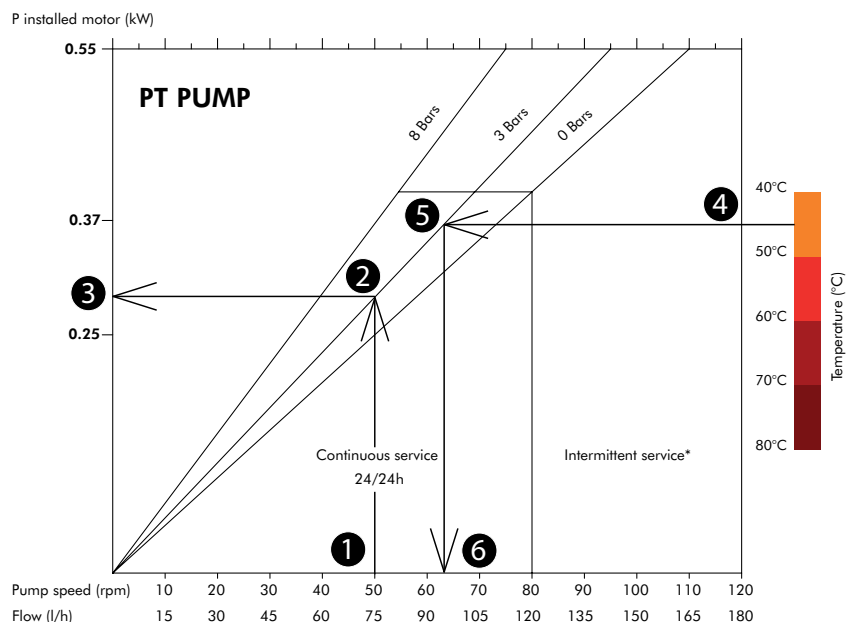

PT peristaltic pumps - technicals characteristics

Flow curves

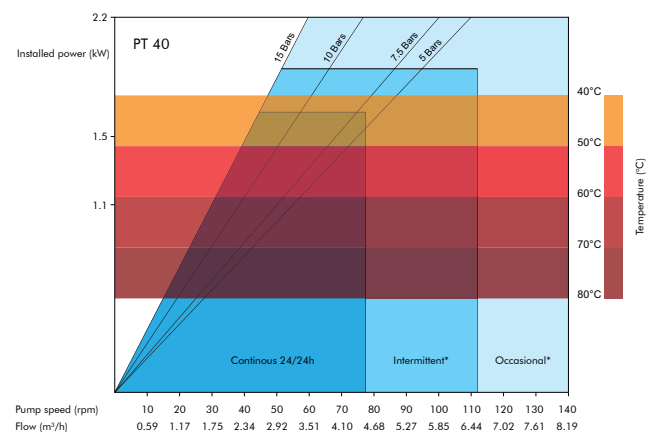
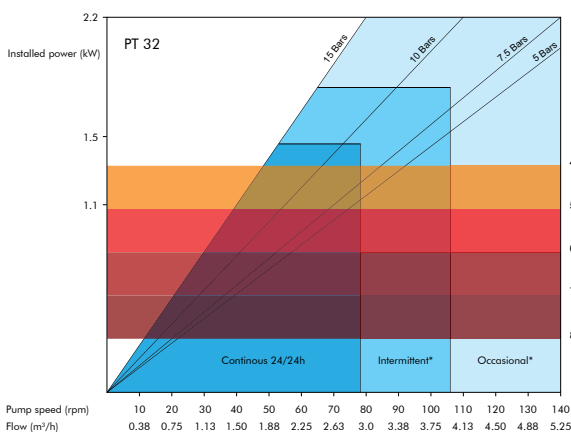
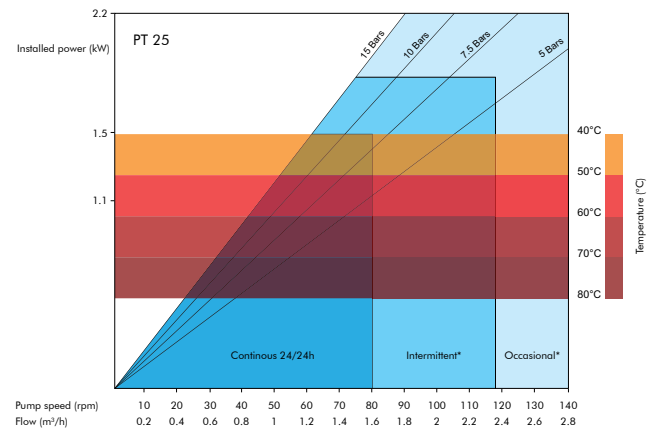
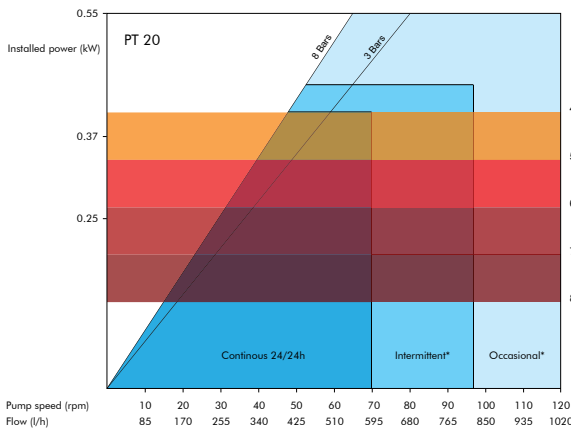
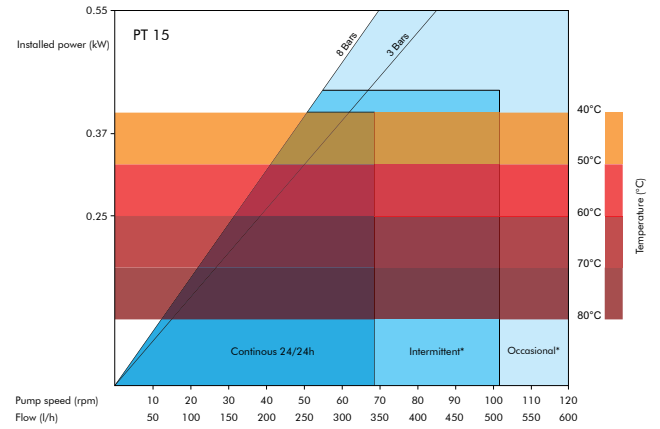
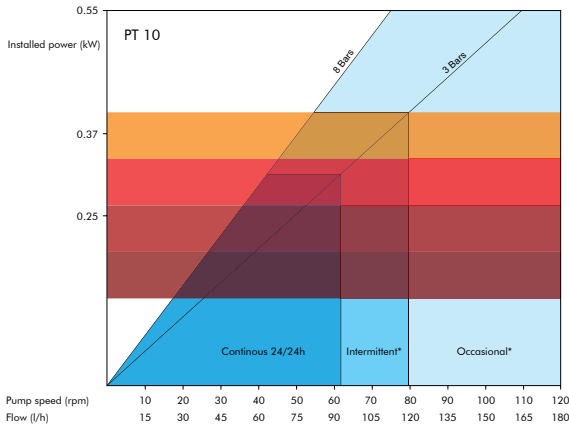
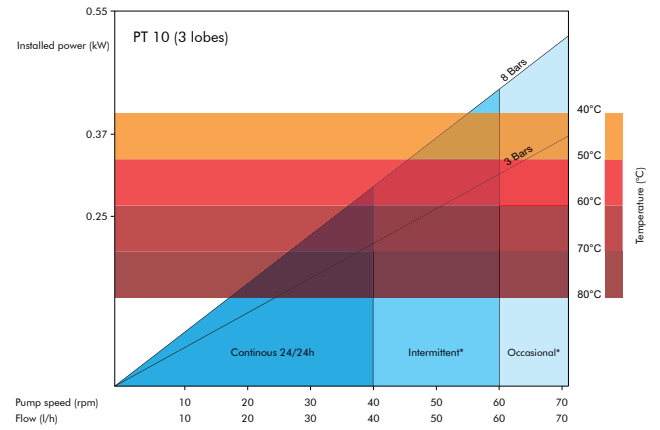
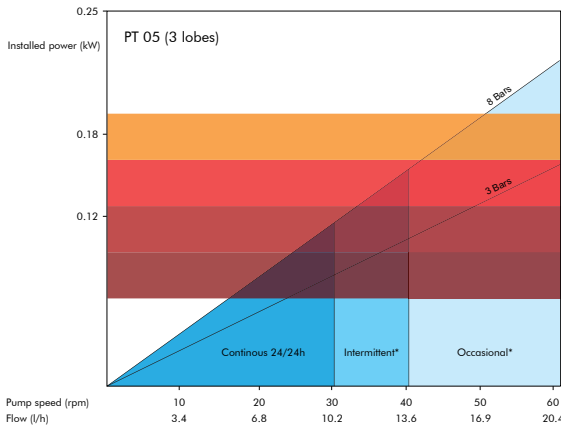

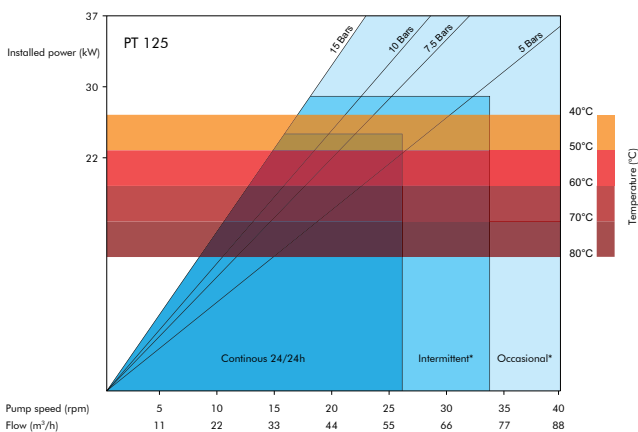
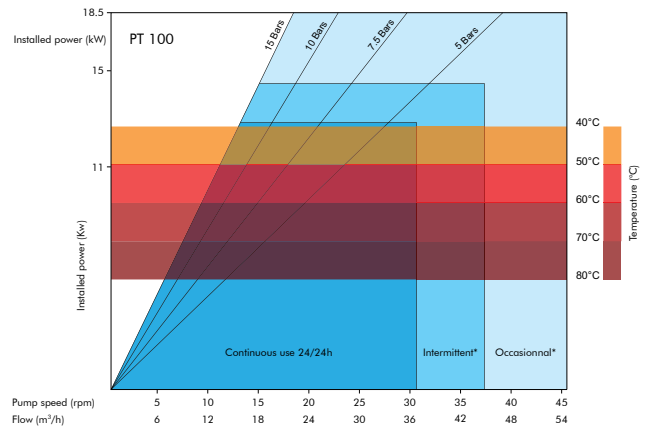
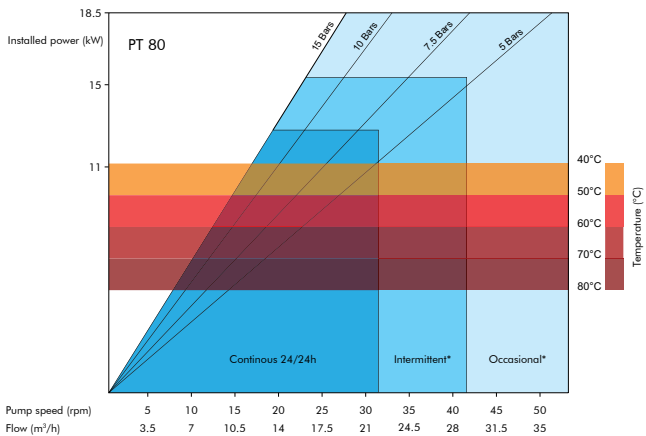
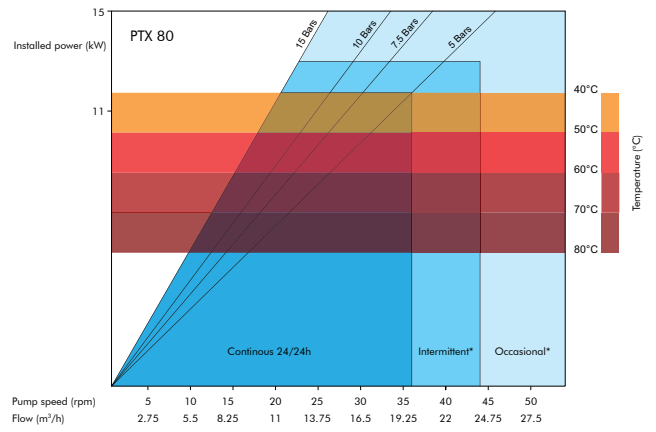
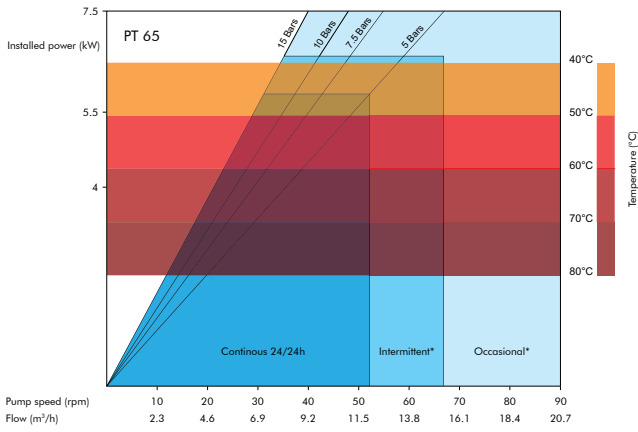
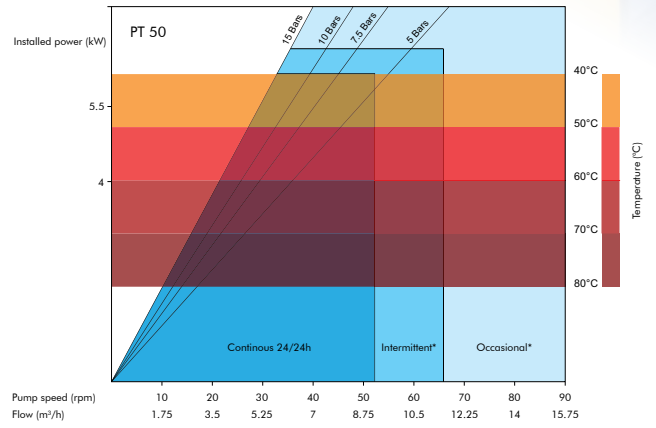
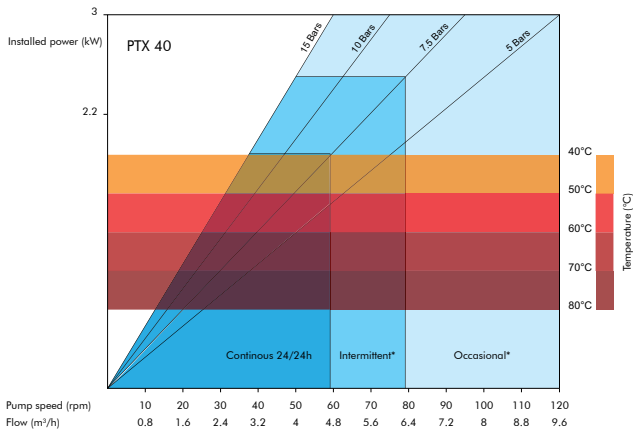

* Intermittent use : Minimum of 1 hour stop after 2 hours use

* Occasional use : Maximum 1 hour per day

Please contact us at your nearest Tapflo office

Tapflo has approximately 50 sales offices spread over more than 20 countries. In addition to this we are represented by independent distributors in about another 30 countries.

- Australia ■ Belarus ■ Belgium ■ Bosnia ■ Brazil ■ Bulgaria ■ Chile ■ China ■ Colombia ■ Croatia ■ Czech/Slovakia ■ Denmark
- Ecuador ■ Estonia ■ Finland ■ France ■ Greece ■ Germany ■ Hong-Kong ■ Hungary ■ India ■ Indonesia ■ Iran ■ Ireland
- Israel ■ Italy ■ Kazakhstan ■ Latvia ■ Lithuania ■ Macedonia ■ Malaysia ■ Montenegro ■ The Netherlands ■ New Zealand
- Norway ■ Poland ■ Philippines ■ Romania ■ Russia ■ Singapore ■ Slovenia ■ South Africa ■ Spain ■ Sweden ■ Switzerland
- Syria ■ Taiwan ■ Thailand ■ Turkey ■ Ukraine ■ United Arab Emirate ■ United Kingdom ■ USA

www.tapflo.com

Belarus

Tapflo Belarus
Tel: +375 17 3121370
sales@tapflo.by

Bulgaria

Tapflo EOOD
Tel: +359 (2) 974 18 54
sofia@tapflo.org

Czech & Slovakia

Tapflo s.r.o.
Tel: +420 548 138 660
tapflo@tapflopump.cz

China

Tapflo (Wuxi)
Tel: +86 510 8241 7602
sales@tapflo.cn

Denmark

Tapflo Danmark
Tel: +45 36 454600
info@tapflo.dk

France

Tapflo France
Tel: +33 1 34 78 82 40
info@tapflo.fr

India

Tapflo Pumps (India)
Tel: +91 44 26534479
tapfloindia@gmail.com

Ireland

Tapflo Ireland Ltd
Tel: +353 1 2011911
info@tapflo.ie

Italy

Tapflo Italia
Tel: +39 0362307698
info@tapfloitalia.com

Kazakhstan

Tapflo Kazakstan
Tel: +7 727 256 05 45
sales@tapflo.kz

Latvia

Tapflo Latvia
Tel: +371 67472205
riga@tapflo.lv

Poland

Tapflo Sp. z o.o.
Tel: +48 58 5301181
gda@tapflo.pl

Romania

S.C. Tapflo Rom. S.r.l.
Tel: +40 21 3451255
sales@tapflo.ro

Russia

Tapflo Company
Tel: +7 495 232 18 28
sales@tapflo.com.ru

Serbia

Tapflo d.o.o.
Tel: +381 21 44 58 08
sales@tapflo.rs

Spain

Tapflo Iberica
Tel: +34 677 47 89 25
avives@tapfloiberica.es

South Africa

Tapflo (Pty) Ltd
Tel: +27 31 701 5255
sales@tapflo.co.za

Turkey

Tapflo Makina Ltd
Tel: +90 216 467 33 11
sales@tapflo.com.tr

Ukraine

TOB Tapflo
Tel: +380 44 222 68 44
sales@tapflo.com.ua

United Kingdom

Tapflo (UK) Ltd
Tel: +44 2380 252325
sales@tapflopumps.co.uk

Tapflo AB

Filaregatan 4
S-442 34 Kungälv, Sweden

E-mail addresses:
Commercial questions
Orders
Tech support

Tel: **+46 303 63390**
Fax: **+46 303 19916**

sales@tapflo.com
order@tapflo.com
support@tapflo.com